

LUMISSION

INVERSO 150 PREMIUM DOWNLIGHTS

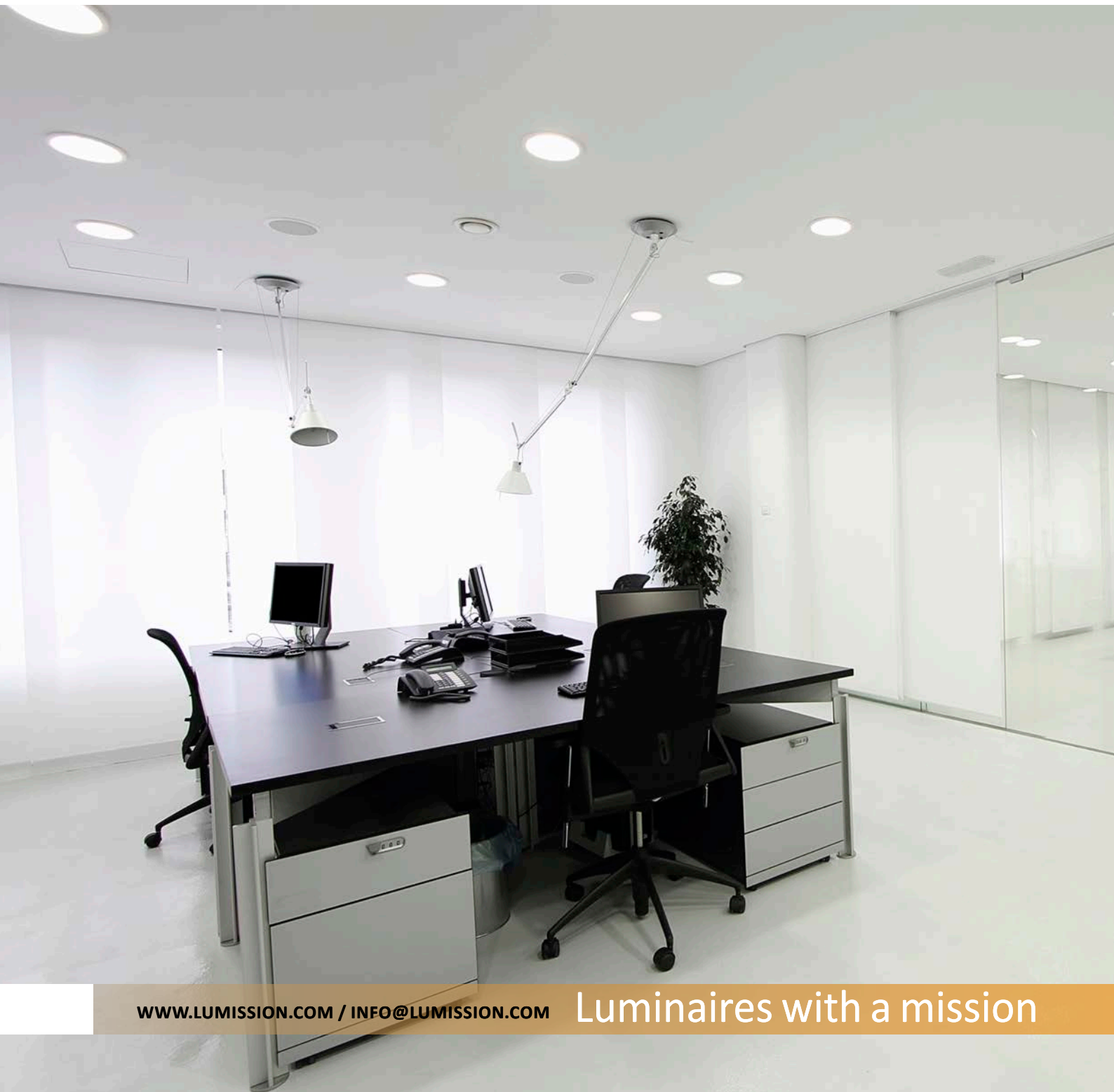

INVERSO 150

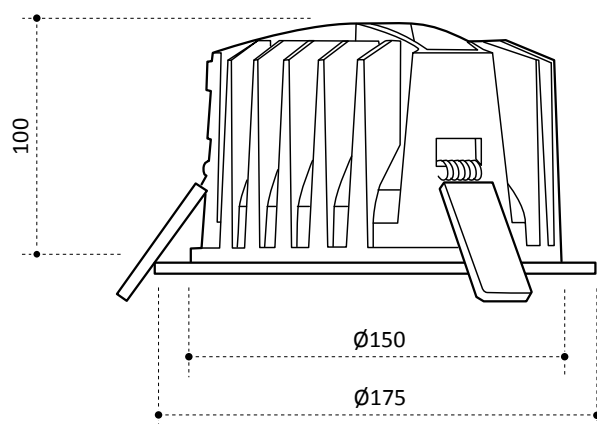

INVERSO 150



















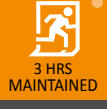

PREMIUM DOWNLIGHTS

Extremely reliable and robust aluminium downlight.

The standard Inverso 150 has a white housing. Accessories like the chrome cone and matt silvergrey cone or the opal cover can easily be clicked in.

For application in offices, shops, meeting rooms, corridors or entrance hall.

Can also be used in humid area's and under canopies.

 1000lm  2000lm LUMINOUS FLUX FIXTURE	CCT	 3000K	 4000K	OTHER ON REQUEST				
	DRIVER	 NON DIMMABLE	 DALI DIMMABLE					
	MOUNTING	 RECESSED	 SURFACE	 PENDANT				
	EMERGENCY UNIT	 3 HRS MAINTAINED	 3 HRS MAINTAINED AUTOMATIC SELFTEST					
	CONNECTION	 DIRECT TO DRIVER	 FAST CONNECTION BOX	 CABLE WITH EUROPLUG	 CABLE WITH WIELAND	 CABLE WITH WINSTA	OTHER ON REQUEST	
	ACCESSORIES	 CONVERSION RING 250MM	 CONVERSION RING 200MM	OTHER ON REQUEST				
	ACCESSORIES	 CONE CHROME	 CONE MATT SILVER	 OPAL				

	INVERSO 150 1000	INVERSO 150 2000
LUMINOUS FLUX MODULE	1400lm	2500lm
LUMINOUS FLUX FIXTURE	1000lm	2000lm
SYSTEM POWER	10W	20W
COLOUR RENDERING (CRI)	>80	>80
COLOUR TEMPERATURE	3000K or 4000K	3000K or 4000K
COLOUR TOLERANCE	<3SDCM	<3SDCM
LIFE	50.000 hrs L90B10	50.000 hrs L90B10
WARRANTY	3 years	3 years
RECESS DIAMETER	Ø150mm	Ø150mm
ALTERNATIVE TO	1x18/26W CFL	2x18/26W CFL

UNIQUE

INVERSO 150

SOME EXAMPLES



MOUNTING: RECESSED
CONE: WHITE
CEILING TRIM: WHITE



MOUNTING: RECESSED
CONE: MATT SILVER
CEILING TRIM: WHITE



MOUNTING: RECESSED
CONE: CHROME
CEILING TRIM: WHITE



MOUNTING: RECESSED
COVER: OPAL
CEILING TRIM: WHITE



MOUNTING: SURFACE
CONE: CHROME
HOUSING: WHITE



MOUNTING: PENDANT
CONE: CHROME
HOUSING: WHITE

★ What makes our product unique?

Reliability and stability

LUMISSION uses very reliable and stable LED's and drivers for its fixtures. Besides that our fixtures have superb cooling, resulting in LED-temperatures far below the maximum allowed values. This results in extremely high reliability and stability over life.

Aging of LED's is indicated by L and B values. The L value indicates the percentage of the initial luminous flux that is maintained after the specified life time. The B value indicates the percentage that does not comply to the L value after specified life time.

The standard in the market nowadays is L70/B50 at 50.000hrs.

The LUMISSION downlights reach L90/B10 after 50.000hrs.

This means that the lightoutput of the LUMISSION downlights during the complete lifetime is almost equal.



Versatility

With the click-in accessories the appearance of the Inverso can easily be transformed. In the standard white version the light softly strikes the white cone. This gives the product an architectural look.

With the chrome cone the reflection is eliminated.

The matt silver grey cone is also softly illuminated, which results in an elegant appearance. Besides that, the matt silver cone is not sensitive to dust and finger prints.

For application in humid area's or under a canopy we recommend the opal cover.

